



**FROMMM** | AIRPAD  
SYSTEMS

## AP100

### Compact airpad system

- Suitable for every work station
- Heavy duty design for continuous operation
- Modular setup for enhanced productivity



## AIRPAD AP100

FROMM's compact airpad device for all protective packaging needs

### Suitable for every work station

- Small footprint for easy integration
- Stand-alone or multiple operator configurations
- Ideal for decentralized packaging stations

### Designed for optimum ergonomics

- Fast learning and user-friendly operation
- Simple control panel
- Silent hopper operation
- Quick and easy film loading
- Rotating display for easy panel reading

### Modular setup for enhanced productivity

- Overhead hoppers and on-floor storage bins
- Automatic replenishment
- Foot switch operation
- Manual pad holder for easy dispensing
- Front and side embedded photocells for automatic use



### FROMM technology

- Heavy duty design for continuous operation
- Efficient technical support
- End-of-the-line expertise



## AP100 Technical specifications

- Power supply: 90-240V-50/60Hz
- Weight: 11,4 kg (without options)
- Speed: 10-16 m/mn
- Film quality: PE
- Film width: 200 mm, 400 mm

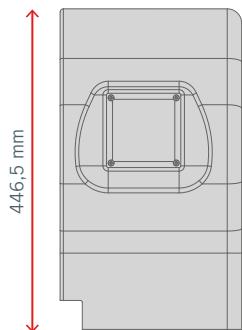
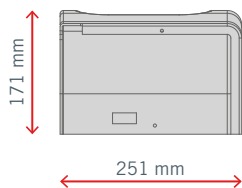

**AirPad AP100**  
code 50.2103

## Options

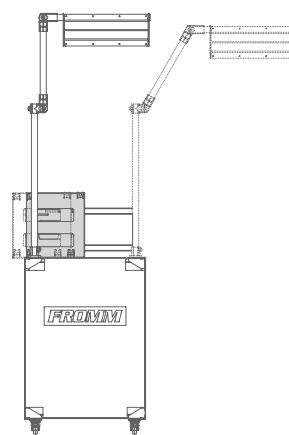
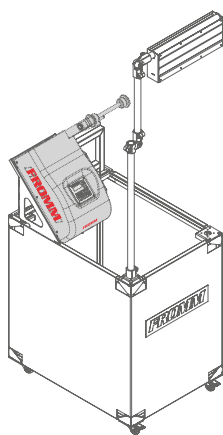

**Compact mobile bin with articulated arm and pad holder**  
code 50.2119

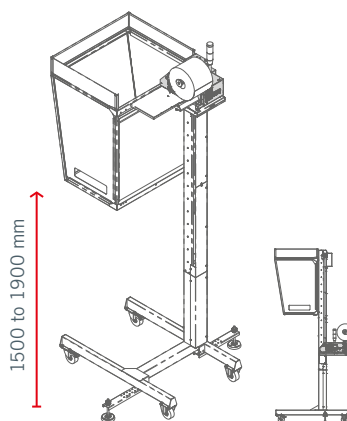



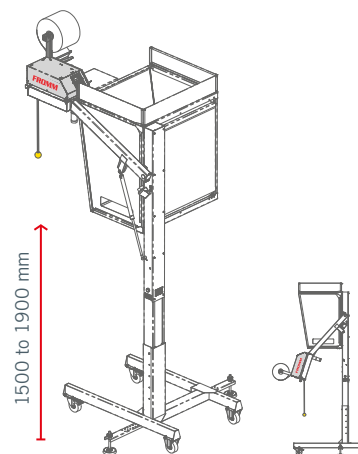











**Electric overhead dispensing system**  
code 50.2118



**Manual overhead dispensing system**  
code 50.2117



# The right film and the right pad

		 <b>Standard</b>	 <b>Strong</b>	 <b>Extra Strong</b>	 <b>Barrier</b>	 <b>Anti-Static</b>	 <b>Recycled</b>	 <b>Bio-based</b>
200x80mm 			900 m 4.0-5.0 m <sup>3</sup> /roll					
200x120mm 				650 m 3.5-4.0 m <sup>3</sup> /roll	<i>In development</i>			
200x135mm 		1100 m 6.0-6.5 m <sup>3</sup> /roll	900 m 5.0-5.5 m <sup>3</sup> /roll			<i>In development</i>	<i>In development</i>	<i>In development</i>
200x200mm 		1100 m 8.5-10.0 m <sup>3</sup> /roll	900 m 7.0-8.0 m <sup>3</sup> /roll					
300x135mm 			600 m 5.0-6.0 m <sup>3</sup> /roll	450 m 3.5-4.0 m <sup>3</sup> /roll				
400x135mm* 			450 m 4.5-5.0 m <sup>3</sup> /roll					
400x150mm* 2 Pads 		500 m 8.5-9.0 m <sup>3</sup> /roll			<i>In development</i>			
400x150mm* 8 Pads 		500 m 200 m <sup>2</sup> /roll		350 m 140 m <sup>2</sup> /roll	<i>In development</i>			

**FROMM** stands for development, production, consultancy, sales, service – worldwide and from a single supplier!  
Benefit from our expertise!

**FROMM** | AIRPAD SYSTEMS

**FROMM HOLDING AG**  
Hinterbergstrasse 26  
CH-6330 Cham  
Switzerland  
Tel. +41 56 419 10 20  
Fax +41 56 419 10 30  
www.fromm-pack.com